

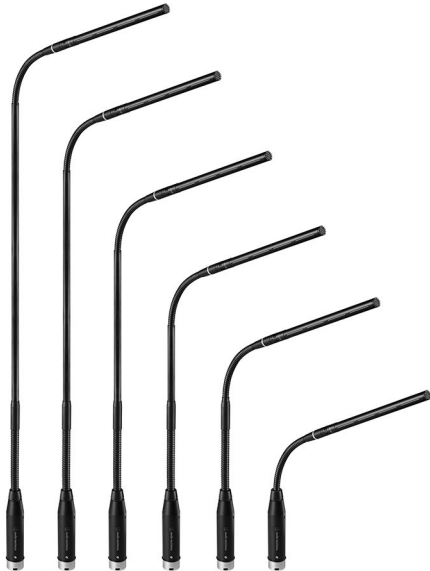

ES925ML6/XLR  
ES925ML12/XLR  
ES925ML15/XLR  
ES925ML18/XLR  
ES925ML21/XLR  
ES925ML24/XLR

User Manual  
MICROLINE CONDENSER  
MODULAR GOOSENECK MICROPHONE  
WITH XLR POWER MODULE



audio-technica

## ■ Introduction

Thank you for purchasing this product. Before using the product, read through the user manual to ensure that you will use the product correctly. Please keep this manual for future reference.

## ■ Features

- Modular microphone system comprised of an ES Series capsule, gooseneck assembly, and power module.
- RGB LED built into the gooseneck assembly can be linked seamlessly with ATUC Series products and the desk stand (AT8699R).
- Insert the power module into a standard XLR-type connector, or use the included quick mount stand adapter (AT8473) to attach it to a microphone stand.
- Cover a wide sound acquisition range from 90° to 360° by replacing the capsule.

## ■ Safety precautions

Although this product was designed to be used safely, failing to use it correctly may result in an accident. To ensure safety, observe all warnings and cautions while using the product.

## ■ Cautions for the product

- Do not subject the product to strong impact to avoid malfunction.
- Do not disassemble, modify or attempt to repair the product.
- Do not handle the product with wet hands to avoid electric shock or injury.
- Do not store the product under direct sunlight, near heating devices or in a hot, humid or dusty place.

## ■ Notes on use

- Do not swing or pull the product. Doing so may cause disconnection or damage.
- The circuitry in the microphone takes about 30 seconds to stabilize after power is supplied. You may hear some audio disturbance during startup.
- Check that the carry case ground is grounded with the mic cable latch firmly engaged before use.
- Do not excessively bend the gooseneck assembly, rotate the ends of the capsule, or pull on them. Doing so may cause disconnection or malfunction.
- The product is a modular system comprised of a microphone element, gooseneck assembly and power module. Make sure the parts are firmly attached before use.
- Do not remove the rubber O-ring on the power module connecting part at the lower section of the gooseneck assembly and the lower part of the XLR power module.
- When attaching parts, remove the black cap on the capsule connecting part of the gooseneck assembly. **Do not remove the silicone part at the end of the capsule connecting part.**



## ■ Assembly

- Insert the gooseneck assembly (c) while rotating it into the XLR power module (d).
    - Tighten until it does not rotate, and use the hex wrench (f) to tighten the set screw (e) and set the gooseneck assembly in place.
    - Connect the capsule (b) to the gooseneck assembly, and attach the windscreen (a).
- \* If the parts are not sufficiently tightened together, problems may occur such as the LED not lighting up to the set color or sound is not output.

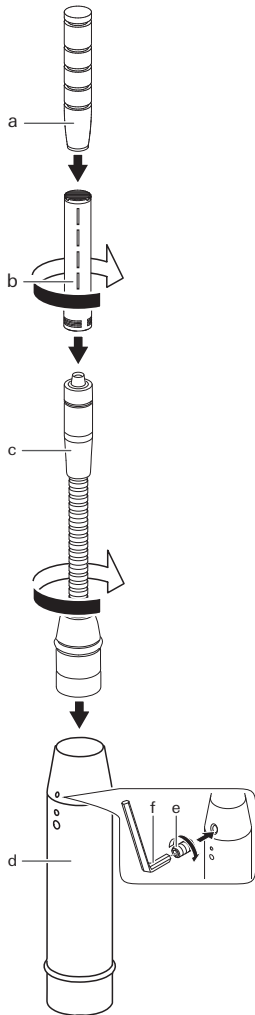

## ■ LED color



▼	1	2	3
OFF	RED	GREEN	YELLOW
4	5	6	7
BLUE	MAGENTA	CYAN	WHITE

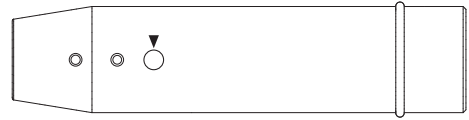

## ■ Wiring

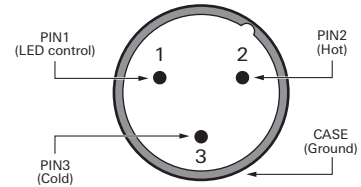

LED control only available with ATUC series products and AT8699R desk stand

- If you are using the AT8474 (optional), make mounting reference holes (with a diameter of 1.5 mm(X) on the circumference of a circle with a diameter of 40 mm (1.6") in the mounting surface.
  - Make a hole with a diameter of 25.4 mm (1") in the center (Y) of the mounting surface for the XLR power module.
  - The outer diameter of the mounting surface is 52.4 mm (2.1") (Z).

### AT8474 (Optional)

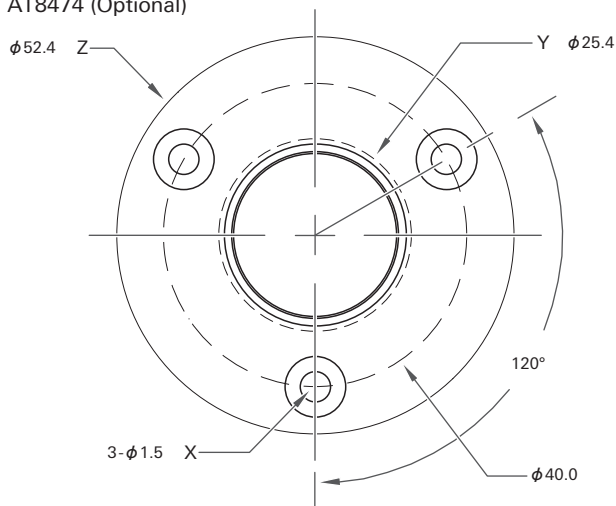

## ■ Specifications

### ES925MLx/XLR

x = 6/12/15/18/21/24

Element	Fixed-charge back plate, permanently polarized condenser
Polar pattern	Line + Gradient
Frequency response	30 - 20,000 Hz
Open circuit sensitivity	-35dB (17.7mV) (0dB=1V/Pa, 1kHz)
Impedance	130 ohms
Maximum input sound level	137 dB SPL (1kHz at 1% THD)
Dynamic range	114 dB (1kHz at Max SPL)
Signal-to-noise ratio	71 dB (1kHz at 1Pa, A-weighted)
Phantom power requirements	11 - 52 V DC, 6.7 mA
Weight	ES925ML6/XLR: 106.2 g (3.7 oz) ES925ML12/XLR: 130.2 g (4.6 oz) ES925ML15/XLR: 135.2 g (4.8 oz) ES925ML18/XLR: 140.2 g (4.9 oz) ES925ML21/XLR: 145.2 g (5.1 oz) ES925ML24/XLR: 150.2 g (5.3 oz)
Dimensions	ES925ML6/XLR: 316.3 mm (12.4") x 20.2 mm (0.8") x 20.2 mm (0.8") ES925ML12/XLR: 423.8 mm (16.7") x 20.2 mm (0.8") x 20.2 mm (0.8") ES925ML15/XLR: 500 mm (19.7") x 20.2 mm (0.8") x 20.2 mm (0.8") ES925ML18/XLR: 576.2 mm (22.7") x 20.2 mm (0.8") x 20.2 mm (0.8") ES925ML21/XLR: 652.4 mm (25.7") x 20.2 mm (0.8") x 20.2 mm (0.8") ES925ML24/XLR: 728.6 mm (28.7") x 20.2 mm (0.8") x 20.2 mm (0.8") (HxWxD)
Output connector	3-Pin XLRM-type
Optional interchangeable elements	ESE-Ca (120°), ESE-Ha (100°), ESE-Oa (360°)
Included accessories	Windscreen AT8138a, Set screw (M2x2 mm (0.08")) 2 pcs., Hex wrench (0.89 mm (0.04"))

## ■ Polar pattern

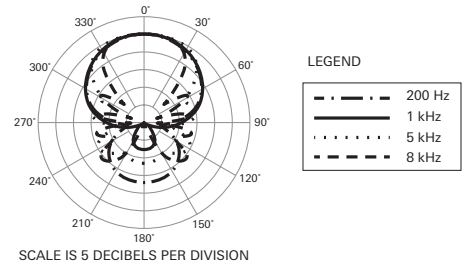

## ■ Frequency response

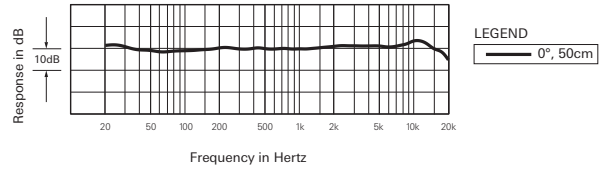

## ■ Dimensions

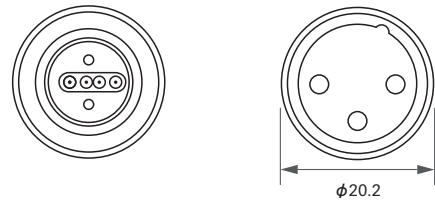

XLR power module (ES8544)

